

VELOCITY TOOLING FOR OKUMA 2SP-H/2SP-HM Series

2SP-250HM Tools

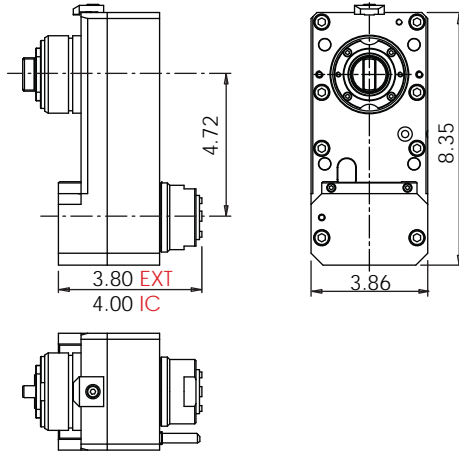

2SP-250HM Cross Tools • ERAX-32 Outputs

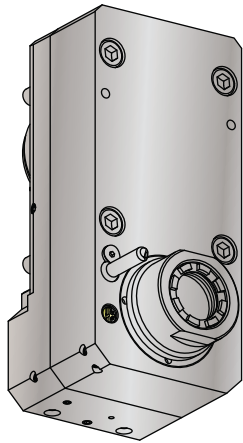

Notes

Wrenches Included with Tools

Maximum Drill Ø		Maximum Mill Ø	
EXT	13/16"	EXT	23/32"
IC	3/4"	IC	23/32"

Turret Plugs 14.430.0.0205.0

* 1,450 psi internal coolant (IC) cross tool **CAN** be run without coolant; the coolant sealing mechanism can be completely dis-engaged.

All coolant thru live tools require 30 micron coolant filtration nominal, 50 micron coolant filtration absolute.

Tool #	Coolant	Output	Rotation (In:Out)	Ratio (In:Out)	Max. RPM	Torque	Spindle Wrench	Collet Wrench
14.101.0.0182.0	EXT	ERAX-32	CW:CW	1:1	5,000	85 Nm	Special	7117.32000
14.101.0.0184.0	IC & EXT* 1,450 psi	ERAXC-32	CW:CW	1:1	5,000	85 Nm	Special	7117.32000

2SP-250HM Face Tools • ER-32 Outputs

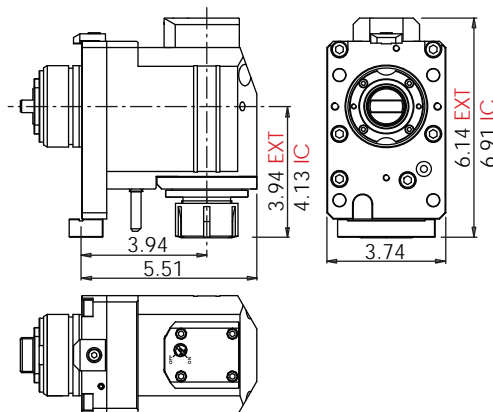
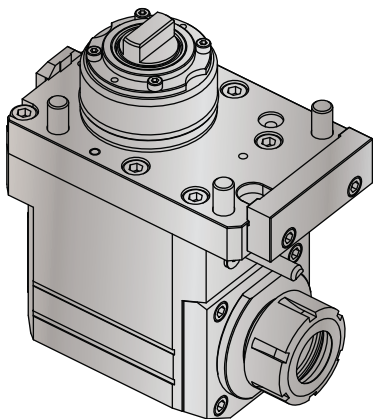

Notes

Wrenches Included with Tools

Maximum Drill Ø		Maximum Mill Ø	
EXT	13/16"	EXT	23/32"
IC	3/4"	IC	23/32"

Turret Plugs 14.430.0.0205.0

* 1,450 psi internal coolant (IC) face tool **CAN** be run without coolant; the coolant sealing mechanism can be completely dis-engaged.

All coolant thru live tools require 30 micron coolant filtration nominal, 50 micron coolant filtration absolute.

Tool #	Coolant	Output	Rotation (In:Out)	Ratio (In:Out)	Max. RPM	Torque	Spindle Wrench	Collet Wrench
14.800.0.0266.0	EXT	ER-32	CW:CW	1:1	5,000	85 Nm	Special	7111.32000
14.800.0.0314.0	IC & EXT* 1,450 psi	ERC-32	CW:CW	1:1	5,000	85 Nm	Special	7111.32000