

OKUMA 2SP-250 HM

5'000 min⁻¹ / rpm
i = 1:1

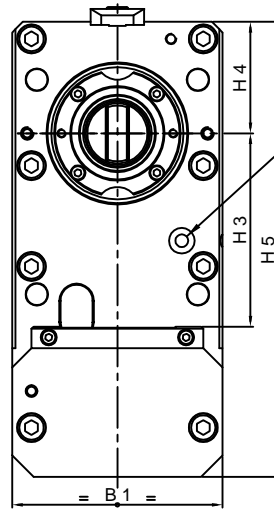
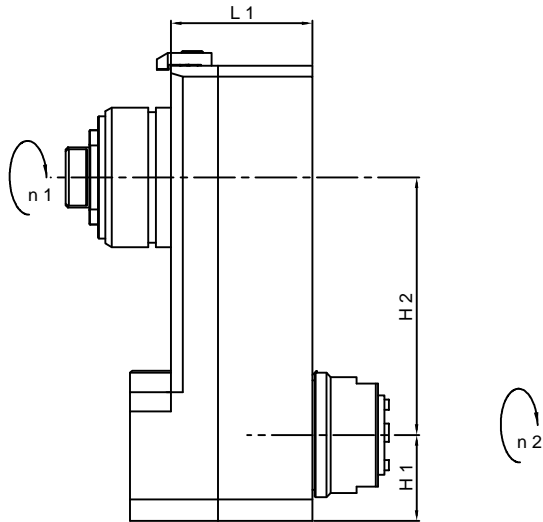
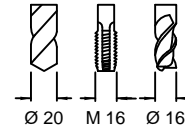

Kühlmitteleingang
Input coolant
Entrata refrigerante
Entrée arrosage

Radial-Fräseinrichtung Radial Milling Unit Unità radiale di fresatura Unité de fraiseage radial	
Externe Kühlung Interne Kühlmittelzuführung P max. = 70 bar kein Trockenlauf!	EKZ IKZ
External coolant supply Coolant through the spindle Coolant pressure max. = 70 bar Don't run without coolant!	ECS CTS
Liquido refrigerante esterno Liquido refrigerante sul fuso Pressione max. = 70 bar Non lavorare a secco!	LRE LRF
Arrosage par l'extérieur Arrosage par le centre Pression max. = 70 bars Ne pas tourner sans arrosage!	APE APC

Spindelvarianten / Spindle executions / Esecuzione fusi / Exécutions de broches

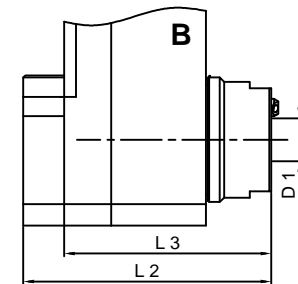
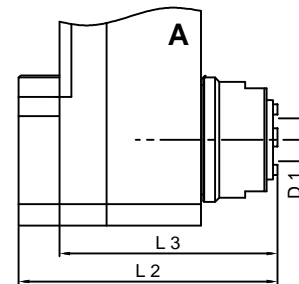
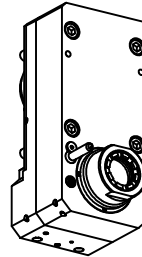
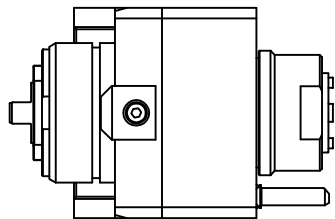

Hi-Q / ERAXC 32

Hi-Q / ERAX 32

	Bestell-Nr. IKZ Ref. No. CTS	Bestell-Nr. EKZ Ref. No. ECS	Radialkopf Radial Head	L 1	L 2	L 3	H 1	H 2	H 3	H 4	H 5	B 1	D 1 Ø	D 2 Ø max.	Nm max.	Schmierung Lubrication	rpm max. min ⁻¹	i n 1 : n 2	Zubehör Accessory	Page
A	14101001840	-	LLUO 85-1 R Hi-Q ERAXC 32	66	101.5	120.5	40	120	90	52	212	98	65	20	85	Fettschmierung Lubricant grease	5'000	1:1	Spannzangen / Collets Dichtscheiben / Sealing Disks	018 021
B	-	14101001820	LLUO 85-1 R Hi-Q ERAX 32	66	96.5	115.5	40	120	90	50	212	98	65	20	85	Fettschmierung Lubricant grease	5'000	1:1	Spannschlüssel / Spanners	