

# VELOCITY TOOLING FOR OKUMA 2SP-H/2SP-HM Series

## 2SP-150H/HM Tools

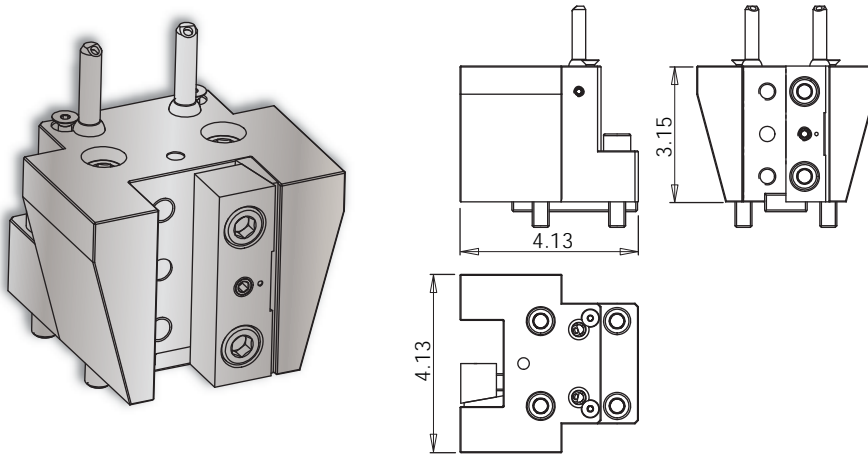

### 2SP-150H/HM OD-I Holder



### Notes

3D Models (.stp) and CAS (.stl) files are available for all *VELOCITY/SU-matic* tool holders. Please contact Velocity: [sales@velocityproducts.com](mailto:sales@velocityproducts.com).

Turret Plugs	14.430.0.0207.0
--------------	-----------------

*VELOCITY/SU-matic* tooling for OKUMA is manufactured on OKUMA machine tools.

*VELOCITY* has the most complete inventory of tooling for OKUMA machine tools in North America.

Tool #

Reversible  
(Main/Sub)

Stick Size

14.910.0.0450.0

No

1.0"

### 2SP-150H/HM OD-II Holder

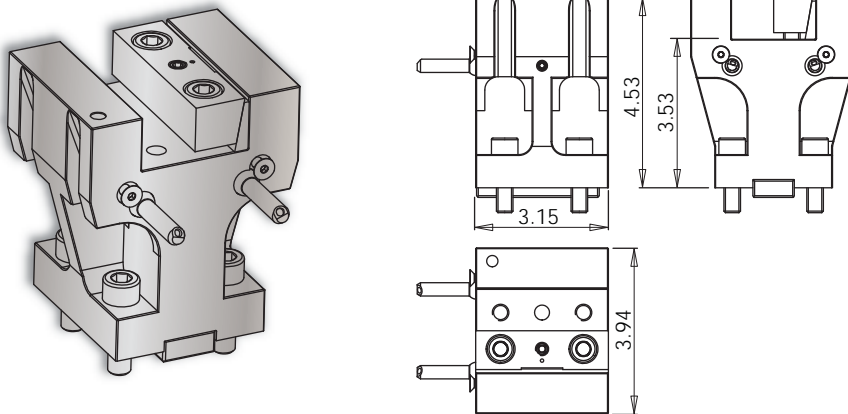

### Notes

3D Models (.stp) and CAS (.stl) files are available for all *VELOCITY/SU-matic* tool holders. Please contact Velocity: [sales@velocityproducts.com](mailto:sales@velocityproducts.com).

Turret Plugs	14.430.0.0207.0
--------------	-----------------

*VELOCITY/SU-matic* tooling for OKUMA is manufactured on OKUMA machine tools.

*VELOCITY* has the most complete inventory of tooling for OKUMA machine tools in North America.

Tool #

Reversible  
(Main/Sub)

Stick Size

14.910.0.0488.0

No

1.0"